

GAS DETECTION SYSTEMS



Contents

Introduction	3
Introduction to Gas Detection Systems	3
Introduction to the Gas Sense System	3
Where to Install a Gas Detector	4
When to Test the Detector	5
Gas Test Concentration	5
Gas Sense Detectors	6
Typical System Connection Diagram	7
Industrial Detector Construction	8
Toxic Detector Specifications	9
Combustible Detector Specification	26
Flame Proof Detector Construction	36
Simplicity Sense Gas Control Panel	37
Zeta Smart Power 27V PSU	38

Zeta Alarm Systems, a trading name of GLT Exports Ltd, was founded in 1985 and is a privately held UK manufacturer of Fire Alarm, Gas Detection and Emergency Systems.

Our brand name is well known throughout the industry and is acclaimed in over forty countries worldwide. We are currently represented in the UK, Europe, Africa, the Middle East, Southern Asia & South America and this list continues to grow.





Introduction to Gas Detection Systems

Gas exposure can be fatal. During everyday life, we will be exposed to a wide range of gasses, which when at low concentration levels, or when carefully controlled & monitored do not pose any danger. But a build up of combustible gas caused by a leak can cause an explosion. Or a build up of toxic gas, such as carbon monoxide can be fatal.

Introduction to the Gas Sense System

With this in mind Zeta Alarm Systems have developed the Gas Sense range of gas detectors. This innovative detector can run as a self contained stand alone detector, or it can be linked to a central monitoring panel where up to 48 detectors can be connected. The detectors can be for the same gas, or for mixed gasses.

In its initial release, detectors will be available for the following gases:-

		
Industrial	Flameproof	
Toxic gases Only	Toxic Gases	Combustible Gases
Chlorine Hydrogen Sulphide Ammonia Nitric Oxide Nitrogen Dioxide Sulphur Dioxide Carbon Monoxide Oxygen	Chlorine Hydrogen Sulphide Ammonia Nitric Oxide Nitrogen Dioxide Sulphur Dioxide Carbon Monoxide Carbon Dioxide Oxygen	N-Butane N-Heptane N-Hexane N-Pentane Propane Methane Ethyl Acetate Isopropyl Alcohol Ethanol Acetone

The modular nature of the design will allow for further gasses to be added in the future.

Where to Install a Gas Detector

Like all gas detectors, the best place to install a Gas Sense detector will depend on the target gas. In general, for gasses lighter than air it will be installed 30-50cm from the ceiling. For gasses heavier than air it will be installed 30-50cm from the floor. For gasses of a similar weight to air, the gas sense detector should be installed close to head height (approx. 1.2 to 2.0m)

The coverage of these detectors will depend on the target gas, and the airflow conditions in the area to be protected. The Typical coverage is 50m².

If the gas detector is being installed to monitor a specific risk, then the detector should be located approximately 1.5m away from that point (This is because if the gas escapes under pressure, it may be forced past the sensor, rather than into it, if the detector is too close).

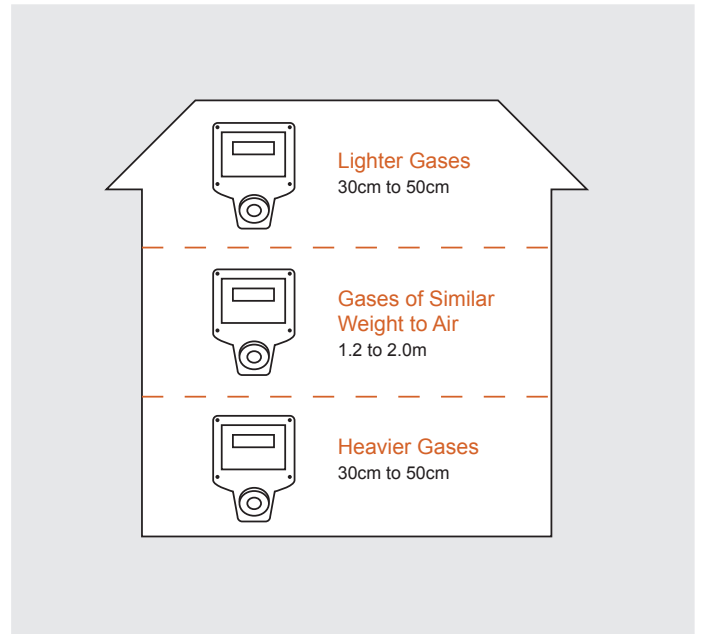

Environmental Factors

When choosing the best place to install the detector, consider all other environmental factors in that area, such as:-

Ventilation or Air Conditioning Vents – Do not place a detector where forced air flow will prevent gas entering the detector.

Open Windows – Airflow through an open window can similarly prevent gas entering the detector.

Dust & Debris – Avoid placing the detector where a constant generation of debris could block the filter, preventing gas from entering the sensor chamber.

Maintenance access – critical detectors should be checked regularly, and the sensor will need to be replaced every 3-5 years. Do not fit to an inaccessible location.

Ceiling beams – if a lighter than air gas is to be detected, large ceiling beams can effect coverage, requiring a detector between each beam.

Gas Type	Molecular Weight
Ammonia	17
Carbon Monoxide	28
Carbon Dioxide	44
Nitrogen Oxide	30
Nitrogen Dioxide	46
Hydrogen Sulphide	34
Sulphur Dioxide	64
Chlorine	70
Oxygen	32
Propane	44
Ethanol	46
N-Butane	58
Acetone	58
Isopropyl Alcohol	60
N-Pentane	72
N-Hexane	86
Ethyl Acetate	88
N-Heptane	100
Methane	16

When to test the detector

Determining the frequency of gas detector testing will depend on a suitable risk analysis of the protected area. For example if the consequences of a leak are small, then checks every 6 months or a year may be acceptable. If the consequences of a leak are severe, then it is good practice to check the detector calibration regularly.

Gas Test Concentration

Generally, a gas detector should be tested with the target gas, with approximately 50% of the detectors rating. For the toxic detectors this would mean:

Gas	Detector Rating	Test Gas
Chlorine	0-20ppm	10ppm
Hydrogen Sulphide	0-100ppm	50ppm
Ammonia	0-100ppm	100ppm
Ammonia	0-300ppm	150ppm
Ammonia	0-1000ppm	500ppm
Ammonia	0-5000ppm	2500ppm
Nitrogen Oxide	0-100ppm	50ppm
Nitrogen Oxide	0-300ppm	150ppm
Nitrogen Dioxide	0-30ppm	15ppm
Sulphur Dioxide	0-20ppm	10ppm
Carbon Monoxide	0-300ppm	150ppm
Carbon Monoxide	0-1000ppm	500ppm

Occasionally it may be preferable to test the detector at a lower concentration. This is acceptable. Just select a concentration to suit the site requirements.

For combustible detectors, Methane must be tested with methane. 2.5% volume would give 50% LEL.

For other combustibles, they can either be tested with the exact gas, or it can be tested with propane.

A cylinder of 50% LEL propane would give readings of:

Gas	Factor	LCD Reading
N-Heptane	0.65	32.5
N-Hexane	0.7	35
N-Pentane	0.75	37.5
Ethyl Acetate	0.85	42.5
N-Butane	0.9	45
Propane	1	50
Acetone	1.05	52.5
Isopropyl Alcohol	1.05	52.5
Ethanol	1.2	60
Methane	1.5	75

Gas Sense Detectors



Features

- Can run in stand alone or system mode
- 3 relay outputs
- 2 x 16 character LCD display
- Each device has 3 sensitivity settings
- Easily replaceable sensor element

Dimensions (mm) & Weight (kg)

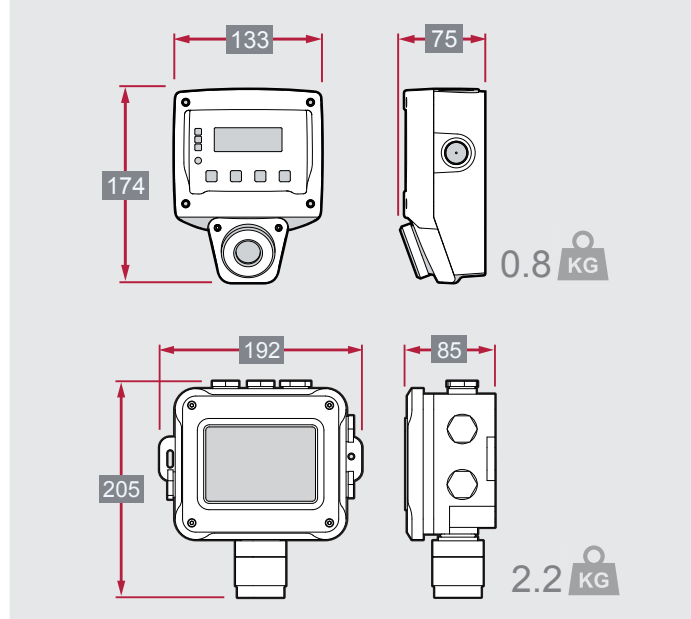

Description

The Zeta Gas Sense detector is a 24V gas detector that can run either in stand alone mode, or can be connected to a control panel for the centralized monitoring of several detectors.

Stand Alone Mode

In stand alone mode, the detector has 3 relay outputs, and a monitored 24V output (Intended for alarm sirens). The 3 relay outputs correspond to the 3 alarm levels of PREALARM, ALARM 1 and ALARM 2. Each of these threshold levels has a default setting, and can be altered by +/- 5% or +/- 10%.

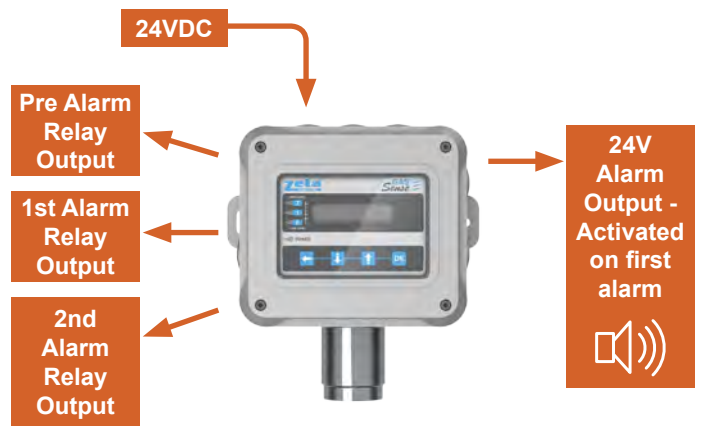

The detector will display the gas type, the current status (normal, fault or alarm), along with the current sensor reading on its 2 x 16 character LCD display. As the gas concentration level rises, the detector will light its relevant alarm LEDs and operate its relays. They operate concurrently, so that in the highest alarm level, all lower alarm LEDs & relays will remain ON.

System Mode

In system mode, the detector will display SYS to indicate that it is now part of a system. It will function similar to when it is in Stand alone mode, except the alarm relays will be under the control of the fire panel. This feature allows the control panel to monitor the system as a whole before deciding whether or not to operate an output.

At the end of the recommended working life of the sensor, a replacement sensor should be fitted. The part numbers for each sensor are shown on the specification table.

Typical System Connection Diagram

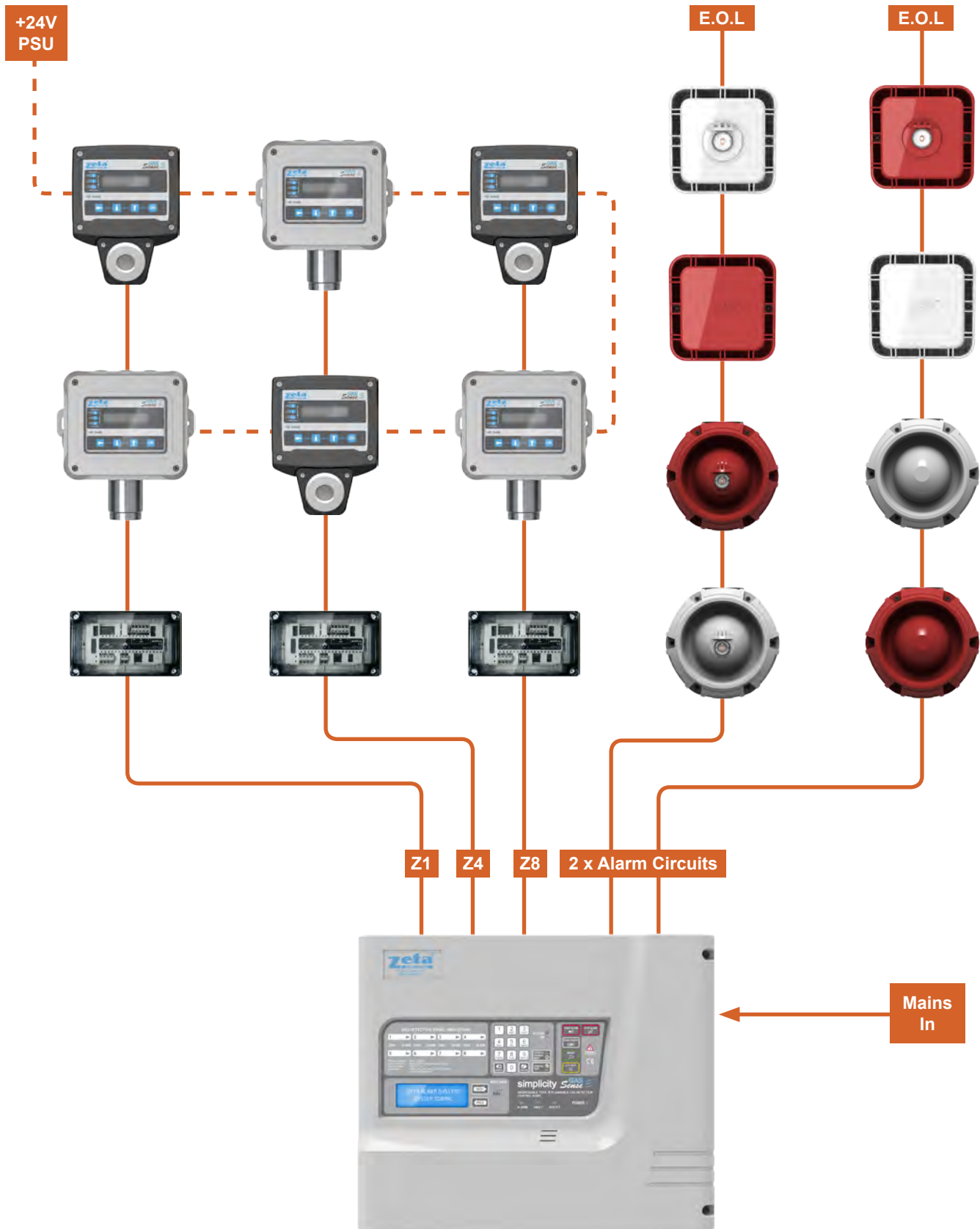

Industrial Detector Construction

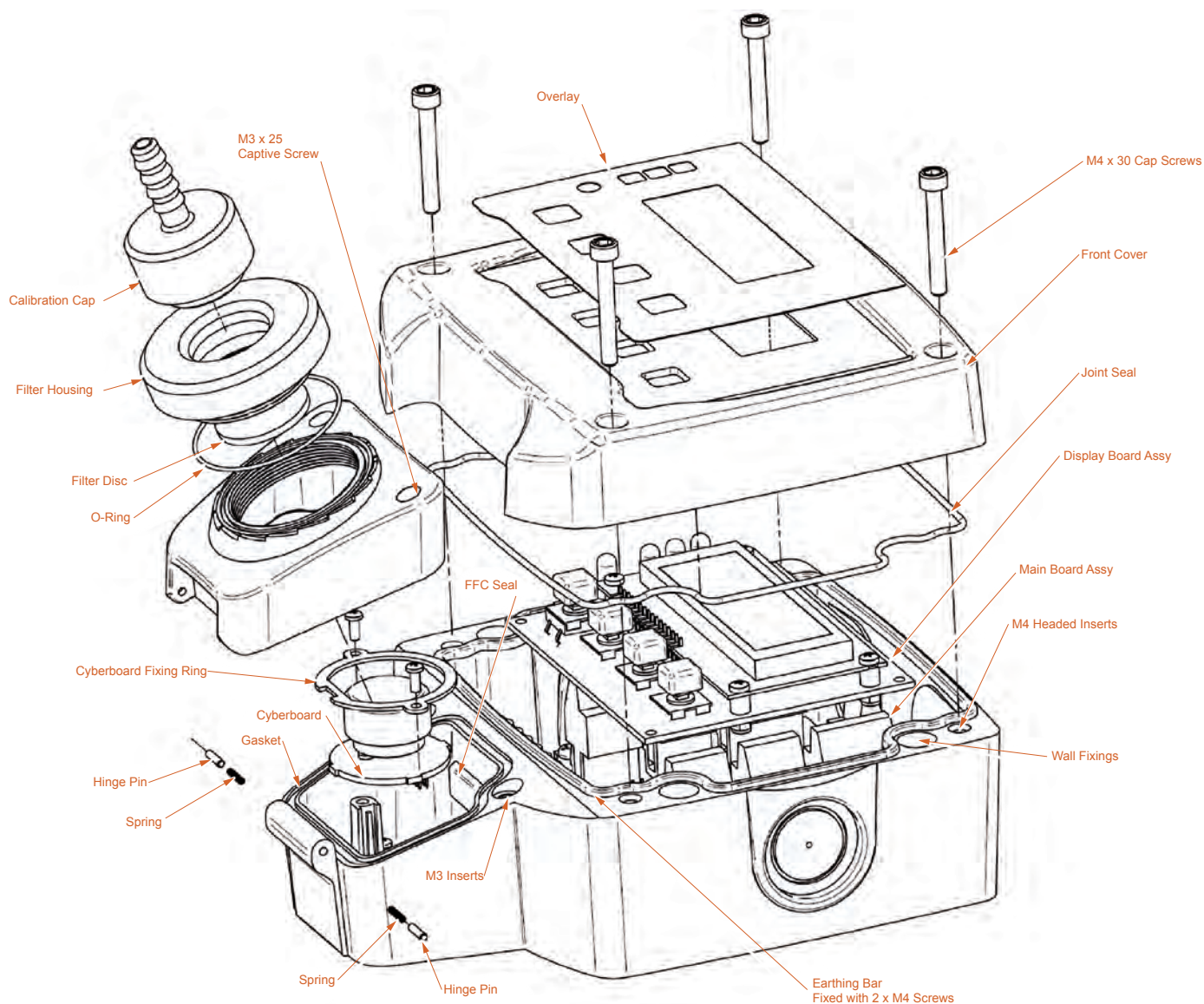

The Detector design consists of 2 chambers. The main chamber houses all the electronics, and is where all electrical connections are made. The second chamber is where the sensor element is located.

This design allows the sensor element to be easily replaced by removing 2 external screws, and 2 internal screws. This avoids all contact with the main electronics. The housing is made from flame retardant ABS. The filter housing is made from stainless steel.

The detector itself has 4 control buttons to allow configuration of the unit. It has a 2 x 16 character LCD display, plus 4 indication LEDs to show its current status. The LEDs are Normal/Fault (2 colour LED), pre-alarm, Alarm 1 and Alarm 2.

Toxic Detector Specifications

Chlorine (CL2)





Description

The ZS-CL2/20 is housed in an IP65 ABS housing with top and side cable entries.

The sensor/cyberboard is housed in a accessible chamber for ease when replacement of sensor is required

Each Gas Sense unit contains 3 indications and 3 relay outputs:

-  Pre-alarm LED with voltage free changeover relay output
-  Alarm 1 indication with voltage free changeover relay output
-  Alarm 2 indication with voltage free changeover relay output

The unit also has a 24Vdc output triggered at alarm.

Technical Specification

Gas Type	Chlorine (CL2)
Model Number	ZS-CL2/20
Part Number	47-550
Target Gas Range	0-20ppm
Replacement Sensor Part Number	CY-DTX-NT-CL2-PL20
Specific Gravity (Air=1)	2.45
Sensor Lifetime	3 Years
Pre-Alarm Settings (ppm) Bold=Default	2.0ppm, 3.0ppm, 4.0ppm , 5.0ppm, 6.0ppm
Alarm 1 Settings (ppm) Bold=Default	4.0ppm, 5.0ppm, 6.0ppm , 7.0ppm, 8.0ppm
Alarm 2 Settings (ppm) Bold=Default	6.0ppm, 7.0ppm, 8.0ppm , 9.0ppm, 10.0ppm
Response Time	<25 Seconds
Operating Voltage	21 – 30VDC
Quiescent Current	48mA (250mA Surge)
Warm-Up Time	2 Minutes
Operating Temperature	-20°C - +50°C
Maximum Humidity	15 % – 90% RH
IP Rating	IP65
Storage Time Without Compromising Lifetime	6 Months from date of manufacture
Recommended Storage Temperature	0°C – 20°C
Gas Sensor Type	Electro Chemical
Dimensions (mm)	174(H) x 133(W) x 75(D)
Weight	0.8kg

Toxic Detector Specifications

Hydrogen Sulphide (H2S)



Description

The ZS-H2S range is housed in an IP65 ABS housing with top and side cable entries.

The sensor/cyberboard is housed in a accessible chamber for ease when replacement of sensor is required

Each Gas Sense unit contains 3 indications and 3 relay outputs:

- Pre-alarm LED with voltage free changeover relay output
- Alarm 1 indication with voltage free changeover relay output
- Alarm 2 indication with voltage free changeover relay output

The unit also has a 24Vdc output triggered at alarm.

Technical Specification

Gas Type	Hydrogen Sulphide (H2S)
Model Number	ZS-H2S/100
Part Number	47-520
Target Gas Range	0-100ppm
Replacement Sensor Part Number	CY-DTX-NT-H2S-PL100
Specific Gravity (Air=1)	1.19
Sensor Lifetime	3 Years
Pre-Alarm Settings (ppm) Bold=Default	010ppm, 015ppm, 020ppm , 025ppm, 030ppm
Alarm 1 Settings (ppm) Bold=Default	020ppm, 025ppm, 030ppm , 035ppm, 040ppm
Alarm 2 Settings (ppm) Bold=Default	030ppm, 035ppm, 040ppm , 045ppm, 050ppm
Response Time	20 Seconds
Operating Voltage	21 – 30VDC
Quiescent Current	48mA (250mA Surge)
Warm-Up Time	2 Minutes
Operating Temperature	-20°C - +50°C
Maximum Humidity	15 % – 90% RH
IP Rating	IP65
Storage Time Without Compromising Lifetime	6 Months from date of manufacture
Recommended Storage Temperature	0°C – 20°C
Gas Sensor Type	Electro Chemical
Dimensions (mm)	174(H) x 133(W) x 75(D)
Weight	0.8kg

Toxic Detector Specifications

Ammonia (NH3)





Description

The ZS-NH3 range is housed in an IP65 ABS housing with top and side cable entries.

The sensor/cyberboard is housed in a accessible chamber for ease when replacement of sensor is required

Each Gas Sense unit contains 3 indications and 3 relay outputs:

-  Pre-alarm LED with voltage free changeover relay output
-  Alarm 1 indication with voltage free changeover relay output
-  Alarm 2 indication with voltage free changeover relay output

The unit also has a 24Vdc output triggered at alarm.

Technical Specification

Gas Type	Ammonia (NH3)			
Model Number	ZS-NH3/100	ZS-NH3/300	ZS-NH3/1000	ZS-NH3/5000
Part Number	47-530	47-533	47-531	47-532
Target Gas Range	0-100ppm	0-300ppm	0-1000ppm	0-5000ppm
Replacement Sensor Part Number	CY-DTX-NT-NH3-PL100	CY-DTX-NT-NH3-PL300	CY-DTX-NT-NH3-PL1000	CY-DTX-NT-NH3-PL5000
Specific Gravity (Air=1)	0.59			
Sensor Lifetime	3 Years			
Pre-Alarm Settings (ppm) Bold=Default	010ppm, 015ppm, 020ppm , 025ppm, 030ppm	030ppm, 045ppm, 060ppm , 075ppm, 090ppm	100ppm, 150ppm, 200ppm , 250ppm, 300ppm	500ppm, 750ppm, 1000ppm, 1250ppm, 1500ppm
Alarm 1 Settings (ppm) Bold=Default	020ppm, 025ppm, 030ppm , 035ppm, 040ppm	060ppm, 075ppm, 090ppm , 105ppm, 120ppm	200ppm, 250ppm, 300ppm , 350ppm, 400ppm	1000ppm, 1250ppm, 1500ppm, 1750ppm, 2000ppm
Alarm 2 Settings (ppm) Bold=Default	030ppm, 035ppm, 040ppm , 045ppm, 050ppm	090ppm, 105ppm, 120ppm , 135ppm, 150ppm	300ppm, 350ppm, 400ppm , 450ppm, 500ppm	1500ppm, 1750ppm, 2000ppm, 2250ppm, 2500ppm
Response Time	<90 Seconds			
Operating Voltage	21 – 30VDC			
Quiescent Current	48mA (250mA Surge)			
Warm-Up Time	2 Minutes			
Operating Temperature	-20°C - +50°C			
Maximum Humidity	15 % – 90% RH			
IP Rating	IP65			
Storage Time Without Compromising Lifetime	6 Months from date of manufacture			
Recommended Storage Temperature	0°C – 20°C			
Gas Sensor Type	Electro Chemical			
Dimensions (mm)	174(H) x 133(W) x 75(D)			
Weight	0.8kg			

Toxic Detector Specifications

Nitric Oxide (NO)



Description

The ZS-NO range is housed in an IP65 ABS housing with top and side cable entries.

The sensor/cyberboard is housed in a accessible chamber for ease when replacement of sensor is required

Each Gas Sense unit contains 3 indications and 3 relay outputs:

- Pre-alarm LED with voltage free changeover relay output
- Alarm 1 indication with voltage free changeover relay output
- Alarm 2 indication with voltage free changeover relay output

The unit also has a 24Vdc output triggered at alarm.

Technical Specification

Gas Type	Nitric Oxide (NO)	
Model Number	ZS-NO/100	ZS-NO/300
Part Number	47-545	47-546
Target Gas Range	0-100ppm	0-300ppm
Replacement Sensor Part Number	CY-DTX-NT-NO-PL100	CY-DTX-NT-NO-PL300
Specific Gravity (Air=1)	1.04	
Sensor Lifetime	3 years	
Pre-Alarm Settings (ppm) Bold=Default	010ppm, 015ppm, 020ppm , 025ppm, 030ppm	030ppm, 045ppm, 060ppm , 075ppm, 090ppm
Alarm 1 Settings (ppm) Bold=Default	020ppm, 025ppm, 030ppm , 035ppm, 040ppm	060ppm, 075ppm, 090ppm , 105ppm, 120ppm
Alarm 2 Settings (ppm) Bold=Default	030ppm, 035ppm, 040ppm , 045ppm, 050ppm	090ppm, 105ppm, 120ppm , 135ppm, 150ppm
Response Time	<25 Seconds	
Operating Voltage	21 – 30VDC	
Quiescent Current	48mA (250mA Surge)	
Warm-Up Time	2 Minutes	
Operating Temperature	-20°C - +50°C	
Maximum Humidity	15 % – 90% RH	
IP Rating	IP65	
Storage Time Without Compromising Lifetime	6 Months from date of manufacture	
Recommended Storage Temperature	0°C – 20°C	
Gas Sensor Type	Electro Chemical	
Dimensions (mm)	174(H) x 133(W) x 75(D)	
Weight	0.8kg	

Toxic Detector Specifications

Nitrogen Dioxide (NO2)





Description

The ZS-NO2 range is housed in an IP65 ABS housing with top and side cable entries.

The sensor/cyberboard is housed in a accessible chamber for ease when replacement of sensor is required

Each Gas Sense unit contains 3 indications and 3 relay outputs:

-  Pre-alarm LED with voltage free changeover relay output
-  Alarm 1 indication with voltage free changeover relay output
-  Alarm 2 indication with voltage free changeover relay output

The unit also has a 24Vdc output triggered at alarm.

Technical Specification

Gas Type	Nitrogen Dioxide (NO2)
Model Number	ZS-NO2/30
Part Number	47-541
Target Gas Range	0-30ppm
Replacement Sensor Part Number	CY-DTX-NT-NO2-PL30
Specific Gravity (Air=1)	1.1
Sensor Lifetime	3 Years
Pre-Alarm Settings (ppm) Bold=Default	3.0ppm, 4.5ppm, 6.0ppm , 7.5ppm, 9.0ppm
Alarm 1 Settings (ppm) Bold=Default	6.0ppm, 7.5ppm, 9.0ppm , 10.5ppm, 12.0ppm
Alarm 2 Settings (ppm) Bold=Default	9.0ppm, 10.5ppm, 12.0ppm , 13.5ppm, 15.0ppm
Response Time	<25 Seconds
Operating Voltage	21 – 30VDC
Quiescent Current	48mA (250mA Surge)
Warm-Up Time	2 Minutes
Operating Temperature	-20°C - +50°C
Maximum Humidity	15 % – 90% RH
IP Rating	IP65
Storage Time Without Compromising Lifetime	6 Months from date of manufacture
Recommended Storage Temperature	0°C – 20°C
Gas Sensor Type	Electro Chemical
Dimensions (mm)	174(H) x 133(W) x 75(D)
Weight	0.8kg

Toxic Detector Specifications

Sulphur Dioxide (SO₂)



Description

The ZS-SO₂ range is housed in an IP65 ABS housing with top and side cable entries.

The sensor/cyberboard is housed in a accessible chamber for ease when replacement of sensor is required

Each Gas Sense unit contains 3 indications and 3 relay outputs:

- Pre-alarm LED with voltage free changeover relay output
- Alarm 1 indication with voltage free changeover relay output
- Alarm 2 indication with voltage free changeover relay output

The unit also has a 24Vdc output triggered at alarm.

Technical Specification

Gas Type	Sulphur Dioxide (SO ₂)
Model Number	ZS-SO ₂ /20
Part Number	47-555
Target Gas Range	0-20ppm
Replacement Sensor Part Number	CY-DTX-NT-SO ₂ -PL20
Specific Gravity (Air=1)	2.26
Sensor Lifetime	3 Years
Pre-Alarm Settings (ppm) Bold=Default	2.0ppm, 3.0ppm, 4.0ppm , 5.0ppm, 6.0ppm
Alarm 1 Settings (ppm) Bold=Default	4.0ppm, 5.0ppm, 6.0ppm , 7.0ppm, 8.0ppm
Alarm 2 Settings (ppm) Bold=Default	6.0ppm, 7.0ppm, 8.0ppm , 9.0ppm, 10.0ppm
Response Time	<25 Seconds
Operating Voltage	21 – 30VDC
Quiescent Current	48mA (250mA Surge)
Warm-Up Time	2 Minutes
Operating Temperature	-20°C - +50°C
Maximum Humidity	15 % – 90% RH
IP Rating	IP65
Storage Time Without Compromising Lifetime	6 Months from date of manufacture
Recommended Storage Temperature	0°C – 20°C
Gas Sensor Type	Electro Chemical
Dimensions (mm)	174(H) x 133(W) x 75(D)
Weight	0.8kg

Toxic Detector Specifications

Carbon Monoxide (CO)





Description

The ZS-CO range is housed in an IP65 ABS housing with top and side cable entries.

The sensor/cyberboard is housed in a accessible chamber for ease when replacement of sensor is required

Each Gas Sense unit contains 3 indications and 3 relay outputs:

-  Pre-alarm LED with voltage free changeover relay output
-  Alarm 1 indication with voltage free changeover relay output
-  Alarm 2 indication with voltage free changeover relay output

The unit also has a 24Vdc output triggered at alarm.

Technical Specification

Gas Type	Carbon Monoxide (CO)	
Model Number	ZS-CO/300	ZS-CO/1000
Part Number	47-510	47-512
Target Gas Range	0-300ppm	0-1000ppm
Replacement Sensor Part Number	CY-DTX-NT-CO-PL300	CY-DTX-NT-CO-PL1000
Specific Gravity (Air=1)	0.97	
Sensor Lifetime	3 Years	
Pre-Alarm Settings (ppm) Bold=Default	030ppm, 045ppm, 060ppm , 075ppm, 090ppm	100ppm, 150ppm, 200ppm , 250ppm, 300ppm
Alarm 1 Settings (ppm) Bold=Default	060ppm, 075ppm, 090ppm , 105ppm, 120ppm	200ppm, 250ppm, 300ppm , 350ppm, 400ppm
Alarm 2 Settings (ppm) Bold=Default	090ppm, 105ppm, 120ppm , 135ppm, 150ppm	300ppm, 350ppm, 400ppm , 450ppm, 500ppm
Response Time	<45 Seconds	
Operating Voltage	21 – 30VDC	
Quiescent Current	48mA (250mA Surge)	
Warm-Up Time	2 Minutes	
Operating Temperature	-20°C - +50°C	
Maximum Humidity	15 % – 90% RH	
IP Rating	IP65	
Storage Time Without Compromising Lifetime	6 Months from date of manufacture	
Recommended Storage Temperature	0°C – 20°C	
Gas Sensor Type	Electro Chemical	
Dimensions (mm)	174(H) x 133(W) x 75(D)	
Weight	0.8kg	

Toxic Detector Specifications

Oxygen (O2)



Description

The ZS-O2 range is housed in an IP65 ABS housing with top and side cable entries.

The sensor/cyberboard is housed in a accessible chamber for ease when replacement of sensor is required

Each Gas Sense unit contains 3 indications and 3 relay outputs:

- Pre-alarm LED with voltage free changeover relay output
- Alarm 1 indication with voltage free changeover relay output
- Alarm 2 indication with voltage free changeover relay output

The unit also has a 24Vdc output triggered at alarm.

Technical Specification

Gas Type	Oxygen (O2)
Model Number	ZS-O2/25%
Part Number	47-730
Target Gas Range	0-25% VOL.
Replacement Sensor Part Number	CY-DO2-NT-O2-A2
Specific Gravity (Air=1)	1.14
Sensor Lifetime	2 Years
Pre-Alarm Settings (ppm)	Depletion Level 13.5% - 18.5% (0.1% Increments)
Alarm 1 Settings (ppm)	Predef Level 18.5% - 22% (0.1% Increments)
Alarm 2 Settings (ppm)	Enrichment Level 20.9% - 25% (0.1% Increments)
Response Time	<15 Seconds
Operating Voltage	21 – 30VDC
Quiescent Current	48mA (250mA Surge)
Warm-Up Time	2 Minutes
Operating Temperature	-20°C - +50°C
Maximum Humidity	15 % – 90% RH
IP Rating	IP65
Storage Time Without Compromising Lifetime	6 Months from date of manufacture
Recommended Storage Temperature	0°C – 20°C
Gas Sensor Type	Electro Chemical
Dimensions (mm)	174(H) x 133(W) x 75(D)
Weight	0.8kg

Toxic Detector Specifications

Chlorine (CL2)





Description

The ZSFP-CL2/20 is a flameproof gas detector with an ATEX approved sensor housing for a fixed detector application.

It comprises of a unique enclosure design with an aluminium housing with 4 gland entries. The enclosure contains the processing electronics and display LCD behind a glass window. The sensor is enclosed in an ATEX approved stainless steel housing.

Each Gas Sense unit contains 3 indications and 3 relay outputs:

-  Pre-alarm LED with voltage free changeover relay output
-  Alarm 1 indication with voltage free changeover relay output
-  Alarm 2 indication with voltage free changeover relay output

The unit can be used as a standalone detector or wired to the Gas Sense panel with a unique protocol communication.

Technical Specification

Gas Type	Chlorine (CL2)
Model Number	ZSFP-CL2/20
Part Number	47-850
Target Gas Range	0-20ppm
Replacement Sensor Part Number	NET32-ATX-NT-CL2-PL20
Specific Gravity (Air=1)	2.45
Sensor Lifetime	3 Years
Pre-Alarm Settings (ppm) Bold=Default	2.0ppm, 3.0ppm, 4.0ppm , 5.0ppm, 6.0ppm
Alarm 1 Settings (ppm) Bold=Default	4.0ppm, 5.0ppm, 6.0ppm , 7.0ppm, 8.0ppm
Alarm 2 Settings (ppm) Bold=Default	6.0ppm, 7.0ppm, 8.0ppm , 9.0ppm, 10.0ppm
Response Time	<25 Seconds
Operating Voltage	21 – 30VDC
Quiescent Current	48mA (250mA Surge)
Warm-Up Time	2 Minutes
Operating Temperature	-20°C - +50°C
Maximum Humidity	15 % – 90% RH
IP Rating	IP65
Storage Time Without Compromising Lifetime	6 Months from date of manufacture
Recommended Storage Temperature	0°C – 20°C
Gas Sensor Type	Electro Chemical
Dimensions (mm)	205(H) x 192(W) x 85(D)
Weight	2.2kg

Toxic Detector Specifications

Hydrogen Sulphide (H2S)





Description

The ZSFP-H2S is a flameproof gas detector with an ATEX approved sensor housing for a fixed detector application.

It comprises of a unique enclosure design with an aluminium housing with 4 gland entries. The enclosure contains the processing electronics and display LCD behind a glass window. The sensor is enclosed in an ATEX approved stainless steel housing.

Each Gas Sense unit contains 3 indications and 3 relay outputs:

-  Pre-alarm LED with voltage free changeover relay output
-  Alarm 1 indication with voltage free changeover relay output
-  Alarm 2 indication with voltage free changeover relay output

The unit can be used as a standalone detector or wired to the Gas Sense panel with a unique protocol communication.

Technical Specification

Gas Type	Hydrogen Sulphide (H2S)
Model Number	ZSFP-H2S/100
Part Number	47-820
Target Gas Range	0-100ppm
Replacement Sensor Part Number	NET32-ATX-NT-H2S-PL100
Specific Gravity (Air=1)	1.19
Sensor Lifetime	3 Years
Pre-Alarm Settings (ppm) Bold=Default	010ppm, 015ppm, 020ppm , 025ppm, 030ppm
Alarm 1 Settings (ppm) Bold=Default	020ppm, 025ppm, 030ppm , 035ppm, 040ppm
Alarm 2 Settings (ppm) Bold=Default	030ppm, 035ppm, 040ppm , 045ppm, 050ppm
Response Time	20 Seconds
Operating Voltage	21 – 30VDC
Quiescent Current	48mA (250mA Surge)
Warm-Up Time	2 Minutes
Operating Temperature	-20°C - +50°C
Maximum Humidity	15 % – 90% RH
IP Rating	IP65
Storage Time Without Compromising Lifetime	6 Months from date of manufacture
Recommended Storage Temperature	0°C – 20°C
Gas Sensor Type	Electro Chemical
Dimensions (mm)	205(H) x 192(W) x 85(D)
Weight	2.2kg

Toxic Detector Specifications

Ammonia (NH3)





Description

The ZSFP-NH3 is a flameproof gas detector with an ATEX approved sensor housing for a fixed detector application.

It comprises of a unique enclosure design with an aluminium housing with 4 gland entries. The enclosure contains the processing electronics and display LCD behind a glass window. The sensor is enclosed in an ATEX approved stainless steel housing.

Each Gas Sense unit contains 3 indications and 3 relay outputs:

-  Pre-alarm LED with voltage free changeover relay output
-  Alarm 1 indication with voltage free changeover relay output
-  Alarm 2 indication with voltage free changeover relay output

The unit can be used as a standalone detector or wired to the Gas Sense panel with a unique protocol communication.

Technical Specification

Gas Type	Ammonia (NH3)			
Model Number	ZSFP-NH3/100	ZSFP-NH3/300	ZSFP-NH3/1000	ZSFP-NH3/5000
Part Number	47-830	47-833	47-831	47-832
Target Gas Range	0-100ppm	0-300ppm	0-1000ppm	0-5000ppm
Replacement Sensor Part Number	NET32-ATX-NT-NH3-PL100	NET32-ATX-NT-NH3-PL300	NET32-ATX-NT-NH3-PL1000	NET32-ATX-NT-NH3-PL5000
Specific Gravity (Air=1)	0.59			
Sensor Lifetime	3 Years			
Pre-Alarm Settings (ppm) Bold=Default	010ppm, 015ppm, 020ppm , 025ppm, 030ppm	030ppm, 045ppm, 060ppm , 075ppm, 090ppm	100ppm, 150ppm, 200ppm , 250ppm, 300ppm	500ppm, 750ppm, 1000ppm, 1250ppm, 1500ppm
Alarm 1 Settings (ppm) Bold=Default	020ppm, 025ppm, 030ppm , 035ppm, 040ppm	060ppm, 075ppm, 090ppm , 105ppm, 120ppm	200ppm, 250ppm, 300ppm , 350ppm, 400ppm	1000ppm, 1250ppm, 1500ppm, 1750ppm, 2000ppm
Alarm 2 Settings (ppm) Bold=Default	030ppm, 035ppm, 040ppm , 045ppm, 050ppm	090ppm, 105ppm, 120ppm , 135ppm, 150ppm	300ppm, 350ppm, 400ppm , 450ppm, 500ppm	1500ppm, 1750ppm, 2000ppm, 2250ppm, 2500ppm
Response Time	<90 Seconds			
Operating Voltage	21 – 30VDC			
Quiescent Current	48mA (250mA Surge)			
Warm-Up Time	2 Minutes			
Operating Temperature	-20°C - +50°C			
Maximum Humidity	15 % – 90% RH			
IP Rating	IP65			
Storage Time Without Compromising Lifetime	6 Months from date of manufacture			
Rec. Storage Temp.	0°C – 20°C			
Gas Sensor Type	Electro Chemical			
Dimensions (mm)	205(H) x 192(W) x 85(D)			
Weight	2.2kg			

Toxic Detector Specifications

Nitric Oxide (NO)



Description

The ZSFP-NO is a flameproof gas detector with an ATEX approved sensor housing for a fixed detector application.

It comprises of a unique enclosure design with an aluminium housing with 4 gland entries. The enclosure contains the processing electronics and display LCD behind a glass window. The sensor is enclosed in an ATEX approved stainless steel housing.

Each Gas Sense unit contains 3 indications and 3 relay outputs:

- Pre-alarm LED with voltage free changeover relay output
- Alarm 1 indication with voltage free changeover relay output
- Alarm 2 indication with voltage free changeover relay output

The unit can be used as a standalone detector or wired to the Gas Sense panel with a unique protocol communication.

Technical Specification

Gas Type	Nitric Oxide (NO)	
Model Number	ZSFP-NO/100	ZSFP-NO/300
Part Number	47-845	47-846
Target Gas Range	0-100ppm	0-300ppm
Replacement Sensor Part Number	NET32-ATX-NT-NO-PL100	NET32-ATX-NT-NO-PL300
Specific Gravity (Air=1)	1.04	
Sensor Lifetime	3 years	
Pre-Alarm Settings (ppm) Bold=Default	010ppm, 015ppm, 020ppm , 025ppm, 030ppm	030ppm, 045ppm, 060ppm , 075ppm, 090ppm
Alarm 1 Settings (ppm) Bold=Default	020ppm, 025ppm, 030ppm , 035ppm, 040ppm	060ppm, 075ppm, 090ppm , 105ppm, 120ppm
Alarm 2 Settings (ppm) Bold=Default	030ppm, 035ppm, 040ppm , 045ppm, 050ppm	090ppm, 105ppm, 120ppm , 135ppm, 150ppm
Response Time	<25 Seconds	
Operating Voltage	21 – 30VDC	
Quiescent Current	48mA (250mA Surge)	
Warm-Up Time	2 Minutes	
Operating Temperature	-20°C - +50°C	
Maximum Humidity	15 % – 90% RH	
IP Rating	IP65	
Storage Time Without Compromising Lifetime	6 Months from date of manufacture	
Recommended Storage Temperature	0°C – 20°C	
Gas Sensor Type	Electro Chemical	
Dimensions (mm)	205(H) x 192(W) x 85(D)	
Weight	2.2kg	

Toxic Detector Specifications

Nitrogen Dioxide (NO2)





Description

The ZSFP-NO2 is a flameproof gas detector with an ATEX approved sensor housing for a fixed detector application.

It comprises of a unique enclosure design with an aluminium housing with 4 gland entries. The enclosure contains the processing electronics and display LCD behind a glass window. The sensor is enclosed in an ATEX approved stainless steel housing.

Each Gas Sense unit contains 3 indications and 3 relay outputs:

-  Pre-alarm LED with voltage free changeover relay output
-  Alarm 1 indication with voltage free changeover relay output
-  Alarm 2 indication with voltage free changeover relay output

The unit can be used as a standalone detector or wired to the Gas Sense panel with a unique protocol communication.

Technical Specification

Gas Type	Nitrogen Dioxide (NO2)
Model Number	ZS-NO2/30
Part Number	47-841
Target Gas Range	0-30ppm
Replacement Sensor Part Number	NET32-ATX-NT-NO2-PL30
Specific Gravity (Air=1)	1.1
Sensor Lifetime	3 Years
Pre-Alarm Settings (ppm) Bold=Default	3.0ppm, 4.5ppm, 6.0ppm , 7.5ppm, 9.0ppm
Alarm 1 Settings (ppm) Bold=Default	6.0ppm, 7.5ppm, 9.0ppm , 10.5ppm, 12.0ppm
Alarm 2 Settings (ppm) Bold=Default	9.0ppm, 10.5ppm, 12.0ppm , 13.5ppm, 15.0ppm
Response Time	<25 Seconds
Operating Voltage	21 – 30VDC
Quiescent Current	48mA (250mA Surge)
Warm-Up Time	2 Minutes
Operating Temperature	-20°C - +50°C
Maximum Humidity	15 % – 90% RH
IP Rating	IP65
Storage Time Without Compromising Lifetime	6 Months from date of manufacture
Recommended Storage Temperature	0°C – 20°C
Gas Sensor Type	Electro Chemical
Dimensions (mm)	205(H) x 192(W) x 85(D)
Weight	2.2kg

Toxic Detector Specifications

Sulphur Dioxide (SO₂)





Description

The ZSFP-SO₂/20 is a flameproof gas detector with an ATEX approved sensor housing for a fixed detector application.

It comprises of a unique enclosure design with an aluminium housing with 4 gland entries. The enclosure contains the processing electronics and display LCD behind a glass window. The sensor is enclosed in an ATEX approved stainless steel housing.

Each Gas Sense unit contains 3 indications and 3 relay outputs:

-  Pre-alarm LED with voltage free changeover relay output
-  Alarm 1 indication with voltage free changeover relay output
-  Alarm 2 indication with voltage free changeover relay output

The unit can be used as a standalone detector or wired to the Gas Sense panel with a unique protocol communication.

Technical Specification

Gas Type	Sulphur Dioxide (SO ₂)
Model Number	ZSFP-SO ₂ /20
Part Number	47-855
Target Gas Range	0-20ppm
Replacement Sensor Part Number	NET32-ATX-NT-SO ₂ -PL20
Specific Gravity (Air=1)	2.26
Sensor Lifetime	3 Years
Pre-Alarm Settings (ppm) Bold=Default	2.0ppm, 3.0ppm, 4.0ppm , 5.0ppm, 6.0ppm
Alarm 1 Settings (ppm) Bold=Default	4.0ppm, 5.0ppm, 6.0ppm , 7.0ppm, 8.0ppm
Alarm 2 Settings (ppm) Bold=Default	6.0ppm, 7.0ppm, 8.0ppm , 9.0ppm, 10.0ppm
Response Time	<25 Seconds
Operating Voltage	21 – 30VDC
Quiescent Current	48mA (250mA Surge)
Warm-Up Time	2 Minutes
Operating Temperature	-20°C - +50°C
Maximum Humidity	15 % – 90% RH
IP Rating	IP65
Storage Time Without Compromising Lifetime	6 Months from date of manufacture
Recommended Storage Temperature	0°C – 20°C
Gas Sensor Type	Electro Chemical
Dimensions (mm)	205(H) x 192(W) x 85(D)
Weight	2.2kg

Toxic Detector Specifications

Carbon Monoxide (CO)





Description

The ZSFP-CO is a flameproof gas detector with an ATEX approved sensor housing for a fixed detector application.

It comprises of a unique enclosure design with an aluminium housing with 4 gland entries. The enclosure contains the processing electronics and display LCD behind a glass window. The sensor is enclosed in an ATEX approved stainless steel housing.

Each Gas Sense unit contains 3 indications and 3 relay outputs:

-  Pre-alarm LED with voltage free changeover relay output
-  Alarm 1 indication with voltage free changeover relay output
-  Alarm 2 indication with voltage free changeover relay output

The unit can be used as a standalone detector or wired to the Gas Sense panel with a unique protocol communication.

Technical Specification

Gas Type	Carbon Monoxide (CO)	
Model Number	ZS-CO/300	ZS-CO/1000
Part Number	47-810	47-812
Target Gas Range	0-300ppm	0-1000ppm
Replacement Sensor Part Number	NET32-ATX-NT-CO-PL300	NET32-ATX-NT-CO-PL1000
Specific Gravity (Air=1)	0.97	
Sensor Lifetime	3 Years	
Pre-Alarm Settings (ppm) Bold=Default	030ppm, 045ppm, 060ppm , 075ppm, 090ppm	100ppm, 150ppm, 200ppm , 250ppm, 300ppm
Alarm 1 Settings (ppm) Bold=Default	060ppm, 075ppm, 090ppm , 105ppm, 120ppm	200ppm, 250ppm, 300ppm , 350ppm, 400ppm
Alarm 2 Settings (ppm) Bold=Default	090ppm, 105ppm, 120ppm , 135ppm, 150ppm	300ppm, 350ppm, 400ppm , 450ppm, 500ppm
Response Time	<45 Seconds	
Operating Voltage	21 – 30VDC	
Quiescent Current	48mA (250mA Surge)	
Warm-Up Time	2 Minutes	
Operating Temperature	-20°C - +50°C	
Maximum Humidity	15 % – 90% RH	
IP Rating	IP65	
Storage Time Without Compromising Lifetime	6 Months from date of manufacture	
Recommended Storage Temperature	0°C – 20°C	
Gas Sensor Type	Electro Chemical	
Dimensions (mm)	205(H) x 192(W) x 85(D)	
Weight	2.2kg	

Toxic Detector Specifications

Carbon Dioxide (CO2)





Description

The ZSFP-CO2 is a flameproof gas detector with an ATEX approved sensor housing for a fixed detector application.

It comprises of a unique enclosure design with an aluminium housing with 4 gland entries. The enclosure contains the processing electronics and display LCD behind a glass window. The sensor is enclosed in an ATEX approved stainless steel housing.

Each Gas Sense unit contains 3 indications and 3 relay outputs:

-  Pre-alarm LED with voltage free changeover relay output
-  Alarm 1 indication with voltage free changeover relay output
-  Alarm 2 indication with voltage free changeover relay output

The unit can be used as a standalone detector or wired to the Gas Sense panel with a unique protocol communication.

Technical Specification

Gas Type	Carbon Dioxide (CO2)		
Model Number	ZSFP-CO2/5000	ZSFP-CO2/5%	ZSFP-CO2/10%
Part Number	47-815	47-816	47-817
Target Gas Range	0-5000ppm	0-5%	0-10%
Replacement Sensor Part Number	NET32-AIN-INP32-CO2P	NET32-AIN-INP32-CO25	NET32-AIN-INP20-CO2D
Specific Gravity (Air=1)	1.52		
Sensor Lifetime	5 Years		
Pre-Alarm Settings (ppm) Bold=Default	500ppm, 750ppm, 1000ppm , 1250ppm, 1500ppm	0.50%, 0.75%, 1.00% , 1.25%, 1.50%	1.00%, 1.50%, 2.00% , 2.50%, 3.00%
Alarm 1 Settings (ppm) Bold=Default	1000ppm, 1250ppm, 1500ppm , 1750ppm, 2000ppm	1.00%, 1.25%, 1.50% , 1.75%, 2.00%	2.00%, 2.50%, 3.00% , 3.50%, 4.00%
Alarm 2 Settings (ppm) Bold=Default	1500ppm, 1750ppm, 2000ppm , 2250ppm, 2500ppm	1.50%, 1.75%, 2.00% , 2.25%, 2.50%	3.00%, 3.50%, 4.00% , 4.50%, 5.00%
Response Time	<25 Seconds		
Operating Voltage	21 – 30VDC		
Quiescent Current	48mA (250mA Surge)		
Warm-Up Time	2 Minutes		
Operating Temperature	-20°C - +50°C		
Maximum Humidity	15 % – 90% RH		
IP Rating	IP65		
Storage Time Without Compromising Lifetime	6 Months from date of manufacture		
Storage Temperature	0°C – 20°C		
Gas Sensor Type	Infra Red		
Dimensions (mm)	205(H) x 192(W) x 85(D)		
Weight	2.2kg		

Toxic Detector Specifications

Oxygen (O2)





Description

The ZSFP-O2/25% is a flameproof gas detector with an ATEX approved sensor housing for a fixed detector application.

It comprises of a unique enclosure design with an aluminium housing with 4 gland entries. The enclosure contains the processing electronics and display LCD behind a glass window. The sensor is enclosed in an ATEX approved stainless steel housing.

Each Gas Sense unit contains 3 indications and 3 relay outputs:

-  Pre-alarm LED with voltage free changeover relay output
-  Alarm 1 indication with voltage free changeover relay output
-  Alarm 2 indication with voltage free changeover relay output

The unit can be used as a standalone detector or wired to the Gas Sense panel with a unique protocol communication.

Technical Specification

Gas Type	Oxygen (O2)
Model Number	ZSFP-O2/25%
Part Number	47-735
Target Gas Range	0-25% VOL.
Replacement Sensor Part Number	NET32-AO2-NT-O2-A2
Specific Gravity (Air=1)	1.14
Sensor Lifetime	3 Years
Pre-Alarm Settings (ppm)	Depletion Level 13.5% - 18.5% (0.1% Increments)
Alarm 1 Settings (ppm)	Predef Level 18.5% - 22% (0.1% Increments)
Alarm 2 Settings (ppm)	Enrichment Level 20.9% - 25% (0.1% Increments)
Response Time	<15 Seconds
Operating Voltage	21 – 30VDC
Quiescent Current	48mA (250mA Surge)
Warm-Up Time	2 Minutes
Operating Temperature	-20°C - +50°C
Maximum Humidity	15 % – 90% RH
IP Rating	IP65
Storage Time Without Compromising Lifetime	6 Months from date of manufacture
Recommended Storage Temperature	0°C – 20°C
Gas Sensor Type	Electro Chemical
Dimensions (mm)	205(H) x 192(W) x 85(D)
Weight	2.2kg

Combustible Detector Specification

N-Butane (C₄H₁₀)





Description

The ZSFP-BUT/1.8% is a flameproof gas detector with an ATEX approved sensor housing for a fixed detector application.

It comprises of a unique enclosure design with an aluminium housing with 4 gland entries. The enclosure contains the processing electronics and display LCD behind a glass window. The sensor is enclosed in an ATEX approved stainless steel housing.

Each Gas Sense unit contains 3 indications and 3 relay outputs:

-  Pre-alarm LED with voltage free changeover relay output
-  Alarm 1 indication with voltage free changeover relay output
-  Alarm 2 indication with voltage free changeover relay output

The unit can be used as a standalone detector or wired to the Gas Sense panel with a unique protocol communication.

Technical Specification

Gas Type	N-Butane (C ₄ H ₁₀)
Model Number	ZSFP-BU/1.8%
Part Number	47-909
Target Gas Range	1.80%
Replacement Sensor Part Number	NET32-AIN-INP20-BUNL
Specific Gravity (Air=1)	2.06
Sensor Lifetime	5 Years
Response Time	20 Seconds
Pre-Alarm Settings (ppm) Bold=Default	010%, 015%, 20% , 25%, 30%
Alarm 1 Settings (ppm) Bold=Default	020%, 025%, 30% , 35%, 40%
Alarm 2 Settings (ppm) Bold=Default	030%, 035%, 40% , 45%, 50%
Operating Voltage	21 – 30VDC (24V Nominal)
Quiescent Current	68mA (250mA Surge)
Warm-Up Time	2 Minutes
Operating Temperature	-20°C - +150°C
Maximum Humidity	95% RH
IP Rating	IP65
Storage Time Without Compromising Lifetime	6 Months from date of manufacture
Recommended Storage Temperature	0°C – 20°C
Gas Sensor Type	Infra Red
Dimensions (mm)	205(H) x 192(W) x 85(D)
Weight	2.2kg

Combustible Detector Specification

N-Heptane (C7H16)





Description

The ZSFP-HEP/1.05% is a flameproof gas detector with an ATEX approved sensor housing for a fixed detector application.

It comprises of a unique enclosure design with an aluminium housing with 4 gland entries. The enclosure contains the processing electronics and display LCD behind a glass window. The sensor is enclosed in an ATEX approved stainless steel housing.

Each Gas Sense unit contains 3 indications and 3 relay outputs:

-  Pre-alarm LED with voltage free changeover relay output
-  Alarm 1 indication with voltage free changeover relay output
-  Alarm 2 indication with voltage free changeover relay output

The unit can be used as a standalone detector or wired to the Gas Sense panel with a unique protocol communication.

Technical Specification

Gas Type	N-Heptane (C7H16)
Model Number	ZSFP-HEP/1.05%
Part Number	47-910
Target Gas Range	1.05%
Replacement Sensor Part Number	NET32-AIN-INP20-HEPL
Specific Gravity (Air=1)	3.45
Sensor Lifetime	5 Years
Response Time	20 Seconds
Pre-Alarm Settings (ppm) Bold=Default	010%, 015%, 20% , 25%, 30%
Alarm 1 Settings (ppm) Bold=Default	020%, 025%, 30% , 35%, 40%
Alarm 2 Settings (ppm) Bold=Default	030%, 035%, 40% , 45%, 50%
Operating Voltage	21 – 30VDC (24V Nominal)
Quiescent Current	68mA (250mA Surge)
Warm-Up Time	2 Minutes
Operating Temperature	-20°C - +150°C
Maximum Humidity	95% RH
IP Rating	IP65
Storage Time Without Compromising Lifetime	6 Months from date of manufacture
Recommended Storage Temperature	0°C – 20°C
Gas Sensor Type	Infra Red
Dimensions (mm)	205(H) x 192(W) x 85(D)
Weight	2.2kg

Combustible Detector Specification

N-Hexane (C₆H₁₄)





Description

The ZSFP-HEX/1.02% is a flameproof gas detector with an ATEX approved sensor housing for a fixed detector application.

It comprises of a unique enclosure design with an aluminium housing with 4 gland entries. The enclosure contains the processing electronics and display LCD behind a glass window. The sensor is enclosed in an ATEX approved stainless steel housing.

Each Gas Sense unit contains 3 indications and 3 relay outputs:

-  Pre-alarm LED with voltage free changeover relay output
-  Alarm 1 indication with voltage free changeover relay output
-  Alarm 2 indication with voltage free changeover relay output

The unit can be used as a standalone detector or wired to the Gas Sense panel with a unique protocol communication.

Technical Specification

Gas Type	N-Hexane (C ₆ H ₁₄)
Model Number	ZSFP-HEX/1.02%
Part Number	47-911
Target Gas Range	1.02%
Replacement Sensor Part Number	NET32-AIN-INP20-HEXL
Specific Gravity (Air=1)	2.97
Sensor Lifetime	5 Years
Response Time	20 Seconds
Pre-Alarm Settings (ppm) Bold=Default	010%, 015%, 20% , 25%, 30%
Alarm 1 Settings (ppm) Bold=Default	020%, 025%, 30% , 35%, 40%
Alarm 2 Settings (ppm) Bold=Default	030%, 035%, 40% , 45%, 50%
Operating Voltage	21 – 30VDC (24V Nominal)
Quiescent Current	68mA (250mA Surge)
Warm-Up Time	2 Minutes
Operating Temperature	-20°C - +150°C
Maximum Humidity	95% RH
IP Rating	IP65
Storage Time Without Compromising Lifetime	6 Months from date of manufacture
Recommended Storage Temperature	0°C – 20°C
Gas Sensor Type	Infra Red
Dimensions (mm)	205(H) x 192(W) x 85(D)
Weight	2.2kg

Combustible Detector Specification

N-Pentane (C5H12)





Description

The ZSFP-PEN/1.4% is a flameproof gas detector with an ATEX approved sensor housing for a fixed detector application.

It comprises of a unique enclosure design with an aluminium housing with 4 gland entries. The enclosure contains the processing electronics and display LCD behind a glass window. The sensor is enclosed in an ATEX approved stainless steel housing.

Each Gas Sense unit contains 3 indications and 3 relay outputs:

-  Pre-alarm LED with voltage free changeover relay output
-  Alarm 1 indication with voltage free changeover relay output
-  Alarm 2 indication with voltage free changeover relay output

The unit can be used as a standalone detector or wired to the Gas Sense panel with a unique protocol communication.

Technical Specification

Gas Type	N-Pentane (C5H12)
Model Number	ZSFP-PEN/1.4%
Part Number	47-913
Target Gas Range	1.40%
Replacement Sensor Part Number	NET32-AIN-INP20-PENL
Specific Gravity (Air=1)	2.49
Sensor Lifetime	5 Years
Response Time	20 Seconds
Pre-Alarm Settings (ppm) Bold=Default	010%, 015%, 20% , 25%, 30%
Alarm 1 Settings (ppm) Bold=Default	020%, 025%, 30% , 35%, 40%
Alarm 2 Settings (ppm) Bold=Default	030%, 035%, 40% , 45%, 50%
Operating Voltage	21 – 30VDC (24V Nominal)
Quiescent Current	68mA (250mA Surge)
Warm-Up Time	2 Minutes
Operating Temperature	-20°C - +150°C
Maximum Humidity	95% RH
IP Rating	IP65
Storage Time Without Compromising Lifetime	6 Months from date of manufacture
Recommended Storage Temperature	0°C – 20°C
Gas Sensor Type	Infra Red
Dimensions (mm)	205(H) x 192(W) x 85(D)
Weight	2.2kg

Combustible Detector Specification

Propane (C3H8)





Description

The ZSFP-PRO/2.1% is a flameproof gas detector with an ATEX approved sensor housing for a fixed detector application.

It comprises of a unique enclosure design with an aluminium housing with 4 gland entries. The enclosure contains the processing electronics and display LCD behind a glass window. The sensor is enclosed in an ATEX approved stainless steel housing.

Each Gas Sense unit contains 3 indications and 3 relay outputs:

-  Pre-alarm LED with voltage free changeover relay output
-  Alarm 1 indication with voltage free changeover relay output
-  Alarm 2 indication with voltage free changeover relay output

The unit can be used as a standalone detector or wired to the Gas Sense panel with a unique protocol communication.

Technical Specification

Gas Type	Propane (C3H8)
Model Number	ZSFP-PRO/2.1%
Part Number	47-914
Target Gas Range	2.10%
Replacement Sensor Part Number	NET32-AIN-INP20-PRO2
Specific Gravity (Air=1)	1.57
Sensor Lifetime	5 Years
Response Time	20 Seconds
Pre-Alarm Settings (ppm) Bold=Default	010%, 015%, 20% , 25%, 30%
Alarm 1 Settings (ppm) Bold=Default	020%, 025%, 30% , 35%, 40%
Alarm 2 Settings (ppm) Bold=Default	030%, 035%, 40% , 45%, 50%
Operating Voltage	21 – 30VDC (24V Nominal)
Quiescent Current	68mA (250mA Surge)
Warm-Up Time	2 Minutes
Operating Temperature	-20°C - +150°C
Maximum Humidity	95% RH
IP Rating	IP65
Storage Time Without Compromising Lifetime	6 Months from date of manufacture
Recommended Storage Temperature	0°C – 20°C
Gas Sensor Type	Infra Red
Dimensions (mm)	205(H) x 192(W) x 85(D)
Weight	2.2kg

Combustible Detector Specification

Methane (CH₄)





Description

The ZSFP-MTE/5.0% is a flameproof gas detector with an ATEX approved sensor housing for a fixed detector application.

It comprises of a unique enclosure design with an aluminium housing with 4 gland entries. The enclosure contains the processing electronics and display LCD behind a glass window. The sensor is enclosed in an ATEX approved stainless steel housing.

Each Gas Sense unit contains 3 indications and 3 relay outputs:

-  Pre-alarm LED with voltage free changeover relay output
-  Alarm 1 indication with voltage free changeover relay output
-  Alarm 2 indication with voltage free changeover relay output

The unit can be used as a standalone detector or wired to the Gas Sense panel with a unique protocol communication.

Technical Specification

Gas Type	Methane (CH ₄)
Model Number	ZSFP-MTE/5.0%
Part Number	47-906
Target Gas Range	5.00%
Replacement Sensor Part Number	NET32-AIN-INP32-CH45
Specific Gravity (Air=1)	0.55
Sensor Lifetime	5 Years
Response Time	20 Seconds
Pre-Alarm Settings (ppm) Bold=Default	010%, 015%, 20% , 25%, 30%
Alarm 1 Settings (ppm) Bold=Default	020%, 025%, 30% , 35%, 40%
Alarm 2 Settings (ppm) Bold=Default	030%, 035%, 40% , 45%, 50%
Operating Voltage	21 – 30VDC (24V Nominal)
Quiescent Current	68mA (250mA Surge)
Warm-Up Time	2 Minutes
Operating Temperature	-20°C - +150°C
Maximum Humidity	95% RH
IP Rating	IP65
Storage Time Without Compromising Lifetime	6 Months from date of manufacture
Recommended Storage Temperature	0°C – 20°C
Gas Sensor Type	Infra Red
Dimensions (mm)	205(H) x 192(W) x 85(D)
Weight	2.2kg

Combustible Detector Specification

Ethyl Acetate (C₄H₈O₂)





Description

The ZSFP-ELA/2.2% is a flameproof gas detector with an ATEX approved sensor housing for a fixed detector application.

It comprises of a unique enclosure design with an aluminium housing with 4 gland entries. The enclosure contains the processing electronics and display LCD behind a glass window. The sensor is enclosed in an ATEX approved stainless steel housing.

Each Gas Sense unit contains 3 indications and 3 relay outputs:

-  Pre-alarm LED with voltage free changeover relay output
-  Alarm 1 indication with voltage free changeover relay output
-  Alarm 2 indication with voltage free changeover relay output

The unit can be used as a standalone detector or wired to the Gas Sense panel with a unique protocol communication.

Technical Specification

Gas Type	Ethyl Acetate (C ₄ H ₈ O ₂)
Model Number	ZSFP-ELA/2.2%
Part Number	47-903
Target Gas Range	2.20%
Replacement Sensor Part Number	NET32-AIN-INP20-EACL
Specific Gravity (Air=1)	3.03
Sensor Lifetime	5 Years
Response Time	20 Seconds
Pre-Alarm Settings (ppm) Bold=Default	010%, 015%, 20% , 25%, 30%
Alarm 1 Settings (ppm) Bold=Default	020%, 025%, 30% , 35%, 40%
Alarm 2 Settings (ppm) Bold=Default	030%, 035%, 40% , 45%, 50%
Operating Voltage	21 – 30VDC (24V Nominal)
Quiescent Current	68mA (250mA Surge)
Warm-Up Time	2 Minutes
Operating Temperature	-20°C - +150°C
Maximum Humidity	95% RH
IP Rating	IP65
Storage Time Without Compromising Lifetime	6 Months from date of manufacture
Recommended Storage Temperature	0°C – 20°C
Gas Sensor Type	Infra Red
Dimensions (mm)	205(H) x 192(W) x 85(D)
Weight	2.2kg

Combustible Detector Specification Isopropyl Alcohol (C3H8O)





Description

The ZSFP-IPA/2.2% is a flameproof gas detector with an ATEX approved sensor housing for a fixed detector application.

It comprises of a unique enclosure design with an aluminium housing with 4 gland entries. The enclosure contains the processing electronics and display LCD behind a glass window. The sensor is enclosed in an ATEX approved stainless steel housing.

Each Gas Sense unit contains 3 indications and 3 relay outputs:

-  Pre-alarm LED with voltage free changeover relay output
-  Alarm 1 indication with voltage free changeover relay output
-  Alarm 2 indication with voltage free changeover relay output

The unit can be used as a standalone detector or wired to the Gas Sense panel with a unique protocol communication.

Technical Specification

Gas Type	Isopropyl Alcohol (C3H8O)
Model Number	ZSFP-IPA/2.2%
Part Number	47-905
Target Gas Range	2.20%
Replacement Sensor Part Number	NET32-AIN-INP20-IPAL
Specific Gravity (Air=1)	2.07
Sensor Lifetime	5 Years
Response Time	20 Seconds
Pre-Alarm Settings (ppm) Bold=Default	010%, 015%, 20% , 25%, 30%
Alarm 1 Settings (ppm) Bold=Default	020%, 025%, 30% , 35%, 40%
Alarm 2 Settings (ppm) Bold=Default	030%, 035%, 40% , 45%, 50%
Operating Voltage	21 – 30VDC (24V Nominal)
Quiescent Current	68mA (250mA Surge)
Warm-Up Time	2 Minutes
Operating Temperature	-20°C - +150°C
Maximum Humidity	95% RH
IP Rating	IP65
Storage Time Without Compromising Lifetime	6 Months from date of manufacture
Recommended Storage Temperature	0°C – 20°C
Gas Sensor Type	Infra Red
Dimensions (mm)	205(H) x 192(W) x 85(D)
Weight	2.2kg

Combustible Detector Specification

Ethanol (C₂H₆O)





Description

The ZSFP-ENL/3.3% is a flameproof gas detector with an ATEX approved sensor housing for a fixed detector application.

It comprises of a unique enclosure design with an aluminium housing with 4 gland entries. The enclosure contains the processing electronics and display LCD behind a glass window. The sensor is enclosed in an ATEX approved stainless steel housing.

Each Gas Sense unit contains 3 indications and 3 relay outputs:

-  Pre-alarm LED with voltage free changeover relay output
-  Alarm 1 indication with voltage free changeover relay output
-  Alarm 2 indication with voltage free changeover relay output

The unit can be used as a standalone detector or wired to the Gas Sense panel with a unique protocol communication.

Technical Specification

Gas Type	Ethanol (C ₂ H ₆ O)
Model Number	ZSFP-ENL/3.3%
Part Number	47-902
Target Gas Range	3.30%
Replacement Sensor Part Number	NET32-AIN-INP20-ETAL
Specific Gravity (Air=1)	1.59
Sensor Lifetime	5 Years
Response Time	20 Seconds
Pre-Alarm Settings (ppm) Bold=Default	010%, 015%, 20% , 25%, 30%
Alarm 1 Settings (ppm) Bold=Default	020%, 025%, 30% , 35%, 40%
Alarm 2 Settings (ppm) Bold=Default	030%, 035%, 40% , 45%, 50%
Operating Voltage	21 – 30VDC (24V Nominal)
Quiescent Current	68mA (250mA Surge)
Warm-Up Time	2 Minutes
Operating Temperature	-20°C - +150°C
Maximum Humidity	95% RH
IP Rating	IP65
Storage Time Without Compromising Lifetime	6 Months from date of manufacture
Recommended Storage Temperature	0°C – 20°C
Gas Sensor Type	Infra Red
Dimensions (mm)	205(H) x 192(W) x 85(D)
Weight	2.2kg

Combustible Detector Specification

Acetone (C3H6O)





Description

The ZSFP-ACE/2.6% is a flameproof gas detector with an ATEX approved sensor housing for a fixed detector application.

It comprises of a unique enclosure design with an aluminium housing with 4 gland entries. The enclosure contains the processing electronics and display LCD behind a glass window. The sensor is enclosed in an ATEX approved stainless steel housing.

Each Gas Sense unit contains 3 indications and 3 relay outputs:

-  Pre-alarm LED with voltage free changeover relay output
-  Alarm 1 indication with voltage free changeover relay output
-  Alarm 2 indication with voltage free changeover relay output

The unit can be used as a standalone detector or wired to the Gas Sense panel with a unique protocol communication.

Technical Specification

Gas Type	Acetone (C3H6O)
Model Number	ZSFP-ACE/2.6%
Part Number	47-900
Target Gas Range	2.60%
Replacement Sensor Part Number	NET32-AIN-INP20-ACTL
Specific Gravity (Air=1)	2
Sensor Lifetime	5 Years
Response Time	20 Seconds
Pre-Alarm Settings (ppm) Bold=Default	010%, 015%, 20% , 25%, 30%
Alarm 1 Settings (ppm) Bold=Default	020%, 025%, 30% , 35%, 40%
Alarm 2 Settings (ppm) Bold=Default	030%, 035%, 40% , 45%, 50%
Operating Voltage	21 – 30VDC (24V Nominal)
Quiescent Current	68mA (250mA Surge)
Warm-Up Time	2 Minutes
Operating Temperature	-20°C - +150°C
Maximum Humidity	95% RH
IP Rating	IP65
Storage Time Without Compromising Lifetime	6 Months from date of manufacture
Recommended Storage Temperature	0°C – 20°C
Gas Sensor Type	Infra Red
Dimensions (mm)	205(H) x 192(W) x 85(D)
Weight	2.2kg

Flameproof Detector Construction

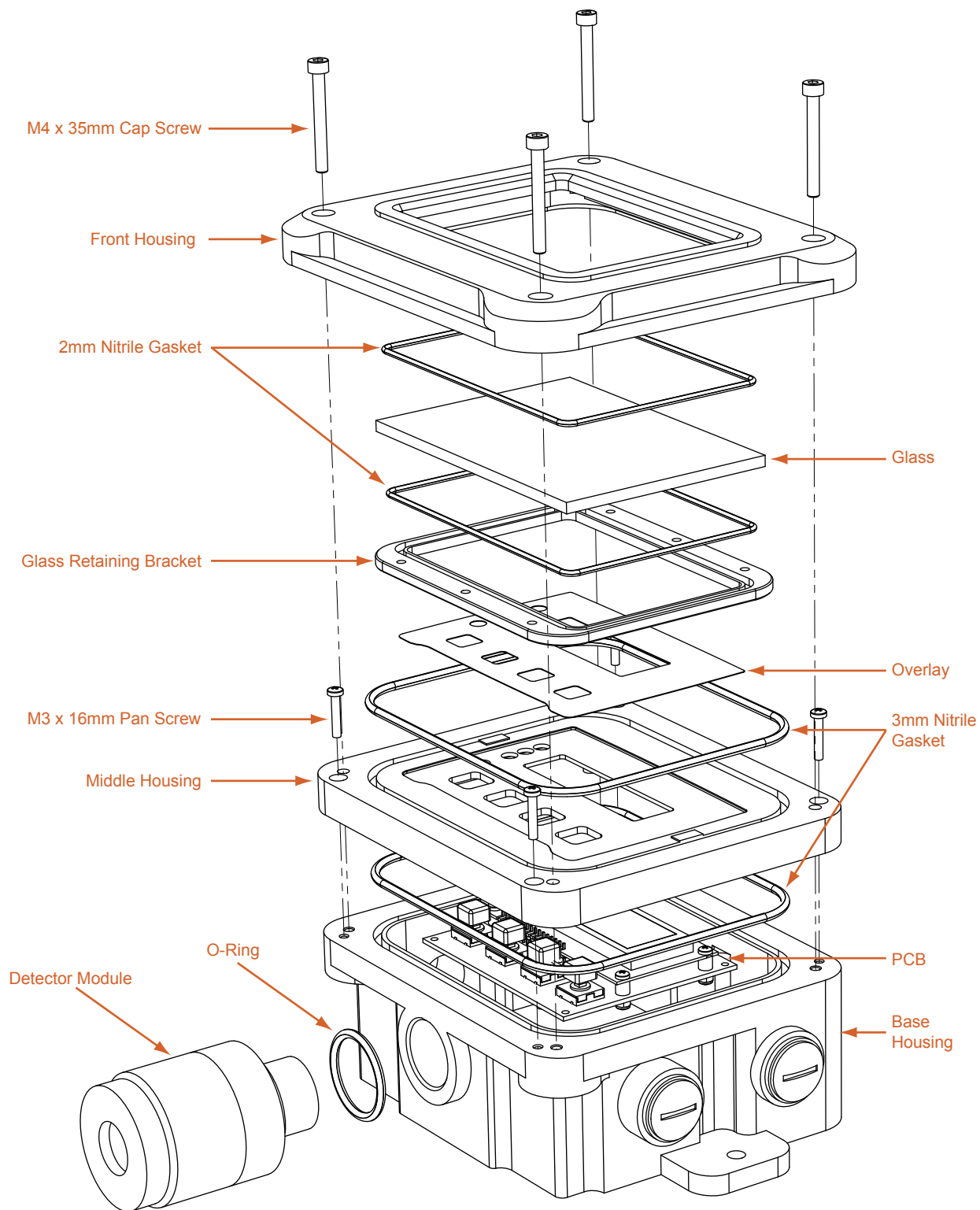

Simplicity Gas Sense Gas Control Panel (SGS100)



NEW



Description

The Simplicity Gas Sense Controller (SGS100) has been designed to monitor and control 48 gas sense detectors.

In addition to this, it can run Zeta addressable I/O units, and the range of Zeta addressable sounders. It has a 4 x 40 character LCD display which helps display all the required device information on the screen.

From the user menu, the status of each detector can be viewed, and its gas concentration level observed. This remote monitoring and checking facility is useful if there are many detectors spread across a wide area on the system.

The system can be divided into 8 zones, allowing detectors to be grouped either by gas type, or by building area.

The Panel has a powerful, but intuitive interface for programming system cause and effect, allowing the various detectors on the system to operate whichever outputs are required.



Dimensions (mm) & Weight (kg)

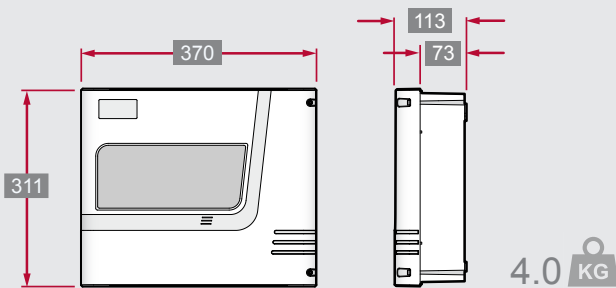

Features

- The SGS100 is for indoor use
- Allows radial or loop wiring
- Integral power supply and charger
- 1024 event memory
- Access code

Technical Specification

Model	SGS100
Part No	47-505
Capacity	48 Gas Sense Devices
Zones	8 Zones
Mains Voltage	230 +/-10% VAC, 50-60 Hz
System Voltage	24 Vdc + 9V Communication (Nominal)
Power Supply	2 Amp PSU
Wiring	8 Radials or 1 loop
Loop Distance	2000m
Alarm Output	2 x 150mA @ 24 Vdc
Panel Size (mm)	370(W) x 311(H) x 113(D)
Space for Batteries	Up to 2 x 7.0 AH SLA Batteries
Weight	4Kg

Smart Power 27V PSU

(ZSP135-DR)



Description

The ZSP135-DR power system is used for supplying the uninterruptible 24V voltage to various fire protection devices.











It conforms to the standards EN 54-4:1997/A2:2006 and EN 12101-10:2005 and guidelines of VdS 2541:1996-12, 2882:2004-11, 2824:2004-03, 2593:2002-09.



Technical Specification

Model	ZSP135-DR-2A-1	ZSP135-DR-3A-1	ZSP135-DR-3A-2	ZSP135-DR-5A-1	ZSP135-DR-5A-2	ZSP135-DR-5A-3	ZSP135-DR-7A-1	ZSP135-DR-7A-2	ZSP135-DR-7A-3
Part No.	46-310	46-3115	46-320	46-325	46-330	46-335	46-340	46-345	46-350
Nominal Input Voltage	230V +10% -15%								
Nominal Output Voltage	27.1V								
Output Voltage Range	19.7 to 28.0V								
Nominal Output Current	1.0A	2.0A	1.5A	4.0A	3.5A	3.0A	6.0A	5.5A	5.0A
Maximal Output Current	2A	3A	3A	5A	5A	5A	7A	7A	7A
Current Consumption	max 35 mA								
Maximal Resistance	250mΩ								
Number of Outputs	2 Fused Outputs								
Working Temperature	-25 to +55°C, 75°C over 2h								
IP Rating	IP44								
Functional class EN 12101-10:2005	A								
Environment class EN 12101-10:2005	1								
Environmental class VdS 2593	III								
Electric safety class EN 60950-1:2006/A11:2009/A1:2010	I								
Type of Box	A	A	B	A	B	C	A	B	C

Features

-  Low quiescent current
-  Battery circuit high resistance indication
-  RS232/485 communication
-  Low failure rate (0.5% for three years)
-  Two outputs
-  Operation state LED indication
-  Remote indication: mains and battery fault (three relay contacts available for each)
-  Output and battery circuits overload protections
-  Internal LVD
-  External alarm input
-  Internal temperature prob

Dimensions (mm) & Weight (kg)

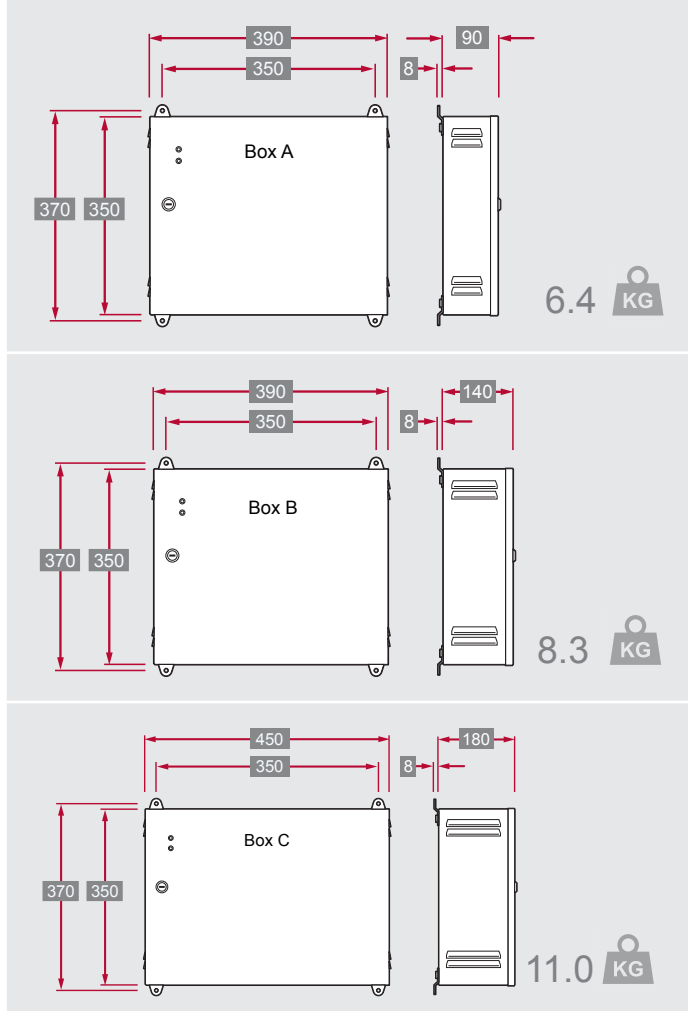

Mechanical Specification

Box Type	Box A	Box B	Box C
Battery Bank Capacity	17Ah	28Ah	40Ah
Dimensions (W x H x D)	390 x 350 x 90	390 x 350 x 140	450 x 350 x 180
Fixing Hole Centres (W x H)	350 x 370	350 x 370	410 x 370
Weight without Batteries	6.4kg	8.3kg	11.0kg
Weight with Batteries	18.0kg	28.3kg	42.3kg



Fire Alarm Systems



Premier EX Pro
Combined Fire & Extinguishing
Control Panel

Quatro Command Centre



Emergency Systems



Premier EVACS 1-16
Voice Alarm System

Fire Telephone



MKII Hard & Soft Addressable Fire Alarm Systems



Available now from:

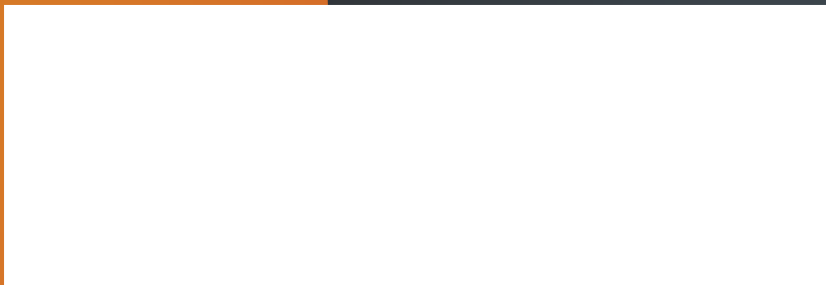

Assessed to ISO 9001: 2008
Certificate number 330

zeta[®]
ALARM SYSTEMS
by GLT Exports Ltd
MADE IN THE UK

Tel: +44 (0) 1792 455 175
Fax: +44 (0) 1792 455 176

Email: info@zetaalarmssystems.com
Web: www.zetaalarmssystems.com

Detection House
72-78 Morfa
Road
Swansea
SA1 2EN
United Kingdom